

Specifications

Model		U55-5		U55-5 Angle Blade		
Type of ROPS / FOPS		Canopy / Cab				
Type of tracks		Rubber, Steel		Rubber, Steel		
Engine	Model	V2607-CR-E5-BH1 / V2607-CR-E5-BH2				
	Output (SAE J1995 gross)	HP (kW) @ rpm	47.6 (35.5) @ 2200			
	Output (SAE J1349 net)	HP (kW) @ rpm	46.4 (34.6) / 45.5 (33.9) @ 2200			
	Displacement	cu. in. (cc)	159.6 (2615)			
Dimensions	Overall length	ft. in. (mm)	17'12" (5475)			
	Overall height	ft. in. (mm)	8'4" (2550)			
	Overall width	ft. in. (mm)	6'5" (1960)			
	Min. ground clearance	in. (mm)	12.2" (310)			
Hydraulic system	Pump capacity	GPM (ℓ/min)	14.8 (56.1) Variable x 2 / 9.8 (37.0) Gear x 1			
	Auxiliary hydraulic flow	AUX1 / AUX2 GPM (ℓ/min)	19.8 (75) / 9.8 (37)			
	Max. breakout force	Bucket / Arm lbs. (kgf)	10172 (4614) / 5869 (2662)			
Drive system	Travel speed	Low / High mph (km/h)	1.8 (2.8) / 3.1 (4.9)			
	Max. traction force	Low speed lbs. (kgf)	14480 (6567)			
	Tumbler distance	ft. in. (mm)	6'6" (1990)			
	Crawler length	ft. in. (mm)	8'2" (2500)			
	Shoe width	Rubber / Steel in. (mm)	15.7" (400)			
	Ground contact pressure	Rubber Canopy / Cab	psi (kgf/cm ²)	4.6 (0.32) / 4.6 (0.33)		4.7 (0.33) / 4.8 (0.34)
		Steel Canopy / Cab	psi (kgf/cm ²)	4.7 (0.33) / 4.7 (0.33)		4.8 (0.34) / 4.9 (0.34)
Swing system	Unit swing speed	rpm	9.2			
	Boom swing angle	Left / Right degree	70 / 55			
Blade	Dimensions	Width	ft. in. (mm)	6'5.2" (1960)		
		Height	ft. in. (mm)	16.1" (410)	16.7" (425)	
	Max. lift above ground	in. (mm)	17.3" (440)		20.1" (510)	
	Max. drop below ground	in. (mm)	15.9" (405)		18.3" (465)	
Angle	Left / Right degree	-		25 / 25		
Hydraulic oil (Reservoir / System)		gal (ℓ)	11.1 (41.9) / 20.3 (77.0)			
Fuel reservoir		gal (ℓ)	17.4 (66.0)			
Operating weight (Including operator's weight @ 165 lbs.)	Rubber Canopy / Cab	lbs. (kgf)	12247 (5555) / 12456 (5650)		12721 (5770) / 12930 (5865)	
	Steel Canopy / Cab	lbs. (kgf)	12533 (5685) / 12743 (5780)		13007 (5900) / 13217 (5995)	

Dimensions

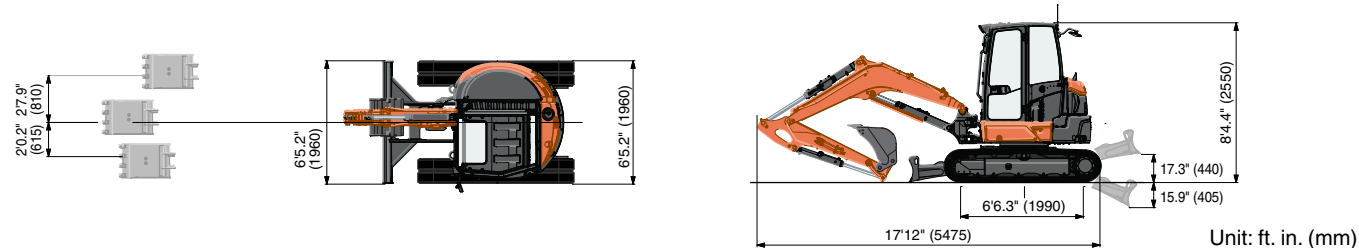

Kubota Tractor Corporation reserves the right to change the stated specifications without notice. This brochure is for descriptive purposes only and reasonable efforts were used to set forth the contained information; some items shown may be optional and some products shown may not be available at all dealerships. Kubota disclaims all representations and warranties, express or implied, or any liability from the use of this brochure. For complete warranty, safety and product information, consult your local Kubota dealer and the operator's manual. Power (HP/KW) and other specifications are based on various standards or recommended practices. For your safety, Kubota strongly recommends the use of a Rollover Protective Structure (ROPS) and seat belt in almost all applications. This brochure is intended for the United States and US territories only. For information regarding Kubota products or services outside these areas, see Kubota Corporation's global web site. Kubota does not provide parts, warranty or service for any Product which is re-sold or retailed in any country other than the country for which the Product(s) were designed or manufactured.

Kubota

KUBOTA TRACTOR CORPORATION

1000 Kubota Drive, Grapevine, TX 76051 Tel 888-4 KUBOTA

Visit our web site at: www.kubotausa.com

©2021 Kubota Corporation



**Kubota
Genuine Parts**
for maximum
performance,
durability and
safety



For Earth, For Life

Kubota

U

KUBOTA TIGHT TAIL SWING COMPACT EXCAVATOR

U55-5

The next generation of tight tail swing compact excavators with advanced performance, comfort, and technology.



OPERATOR COMFORT / EASE OF USE

A bigger cab with enhanced insulation, improved visibility, and a wealth of new comfort features.

Spacious & Comfortable Cab

With new interior designs, the cabs offer improved comfort for operators of any size. The designs feature a slimmer, more ergonomically positioned right meter panel, a double adjustable seat and greater head and foot space. The result is more room and greater comfort for the operator, and that means improved productivity on the job.

Expanded Glass Area

A slimmer frame design means 20% more glass in the front window, skylight, and left and right windows. Operators can monitor the left and right edges of the dozer as well as the bucket through the skylight—it also enhances the feeling of spaciousness in the cab.



Double Adjustable Seat

As part of the new design, the cab is now equipped with a seat with a slide that can be double-adjusted to improve comfort. The joystick consoles on the left and right sides of the seat also can be adjusted independently of the seat to match individual operator requirements. An optional air suspension seat is also available for additional comfort.



A Back-lit Key Pad

Redesigned for greater comfort and improved operability, the key pad features a compact profile and places all of the main switches on the right side for easier access.

B Enhanced Legroom

The new cab design and interior layout not only optimize operability, but also provide much more foot space for greater operator comfort.

Air Conditioner

The air conditioner duct now directs air to the back of the operator's neck to enhance the effect and efficiency of the air conditioning.



Low Noise*

World-class noise reduction technology helps protect the operator's ears as well as provides a more stress-free working environment for the operator. Rear engine noise is reduced by a metal partition between the engine and the cab. The floor plate is also thicker to reduce noise from beneath the cab.

74dB*

* Noise Level for Cab Spec



PERFORMANCE

Advanced Kubota Engines and hydraulic systems ensure superior performance and operability in real-world working conditions.



Automatic Activation of 3rd Line Hydraulic Return

No more climbing down from the cab and reaching under the bonnet to manually open and close the 3rd line hydraulic return. The U55-5 features an electronically controlled 3rd line hydraulic return that is automatically activated when the operator selects one way flow mode on the digital panel in the cab.

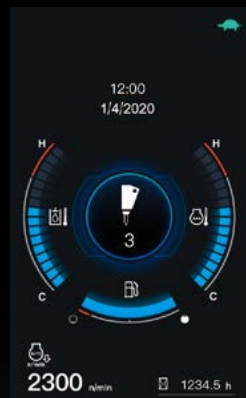

Kubota Original DI Engine with CRS and DPF Muffler

The new Kubota's direct-injection engine is equipped with CRS and with a new and improved DPF which reduces maintenance by increasing the service intervals for both the regeneration filter and ash cleaner.

Automatic Regeneration System

DPF regeneration (PM combustion stroke) is performed automatically, before soot reaches a critical level, so the operator never needs to stop work to clean the DPF.

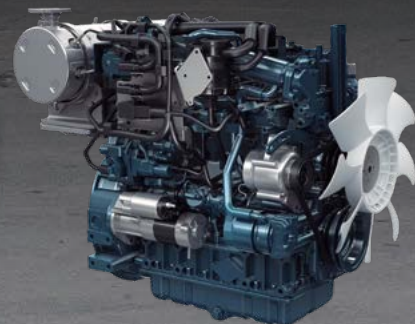

Working Range

Kubota's new 5-ton compact excavators deliver impressive performance and efficiency for their size, with exceptional bucket digging force, outstanding arm reach, and a well-matched arm and bucket. Even tough digging jobs will get done faster and more efficiently.

Versatile Control

Two auxiliary circuits (AUX1 and AUX2) are available on the U55-5. The maximum oil flow settings of both circuits are conveniently adjustable from the digital panel. No additional tools or complex manual adjusting procedures are necessary.

Load Sensing Hydraulic System

Kubota's load sensing hydraulic system ensures smoother operation, regardless of load size. It allows hydraulic oil to flow according to the specific range of the operator's lever motion. The result is greater fuel economy and smoother travelling.

Hydraulic Angle Blade

Save time and work more efficiently. With a simple movement of the dozer lever, the hydraulic Angle Blade can be angled to the right or left to push soil to the side as the machine moves forward, eliminating the need for repetitive repositioning at right angles when backfilling trenches.

A Bolt-on Cutting Edge*

*Standard on Angle Blade models.

B Durable Fixed Hook

25° Pivot Angle

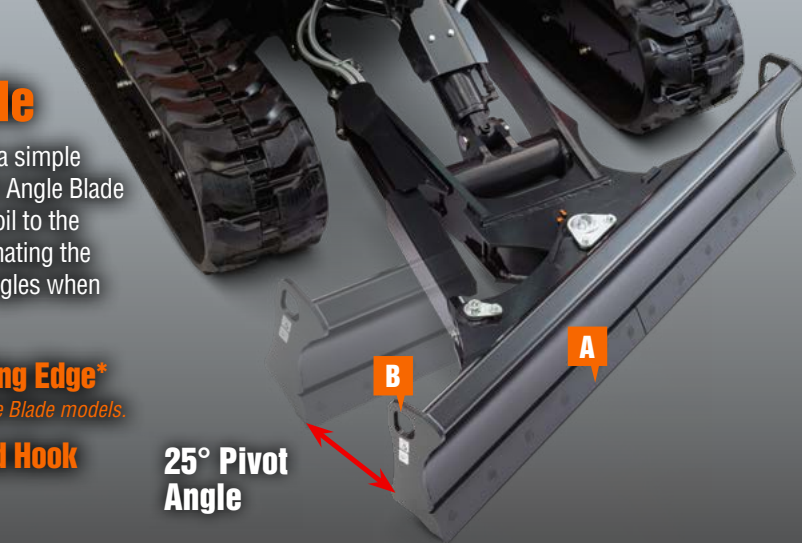

Dozer Blade Float

You don't need to adjust the dozer height to make a clean ground surface. After backfilling, just travel backward along the covered ditch with the dozer in the float position. Ground finishing work is now fast and easy!



Auto-shift

The auto-shift system enables automatic travel shift from high to low depending on traction effort and terrain. This gives smoother operations when dozing and turning.

Auto Idling System

When the control levers are in neutral for more than 4 seconds, engine RPM automatically idles. Move any control lever, and engine RPM immediately returns. This innovative feature not only lowers noise and exhaust emissions, but also reduces operating cost and fuel consumption. It can be turned on and off.



TECHNOLOGY

Advanced technology and optional items help keep the operator and bystanders informed about the machine.

Keyless Start (option)

Optional keyless start is available for Kubota compact excavators. The engine can be started by entering a 4 digit passcode using the excavator key pad and up to 10 user passwords can be set. With this new function, customers do not have to worry about lost keys anymore.

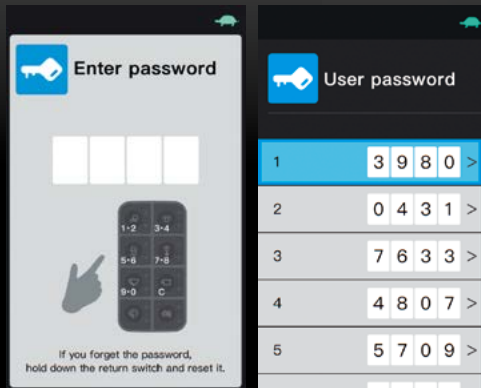

Travel Alarm (option)

An optional travel alarm alerts nearby workers that the compact excavator is on the move.

LED Work Lights with Turn-off Delay

The LED work lights can be programmed to turn off 30 seconds to 2 minutes after the engine has stopped. This allows the operator to exit the machine and walk away safely under full illumination.

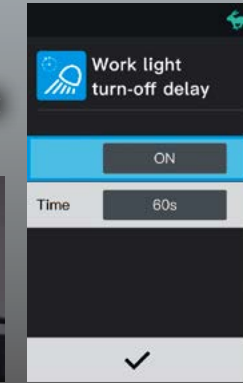

Rear-view Camera (option)

Factory designed rear-view camera provides a fish-eye view to the rear of the compact excavator by displaying the view on the 7" LCD screen in the cab.



SERVICE

A fully opening bonnet and optimum arrangement of internal parts realize quick and efficient service and shorter downtime.

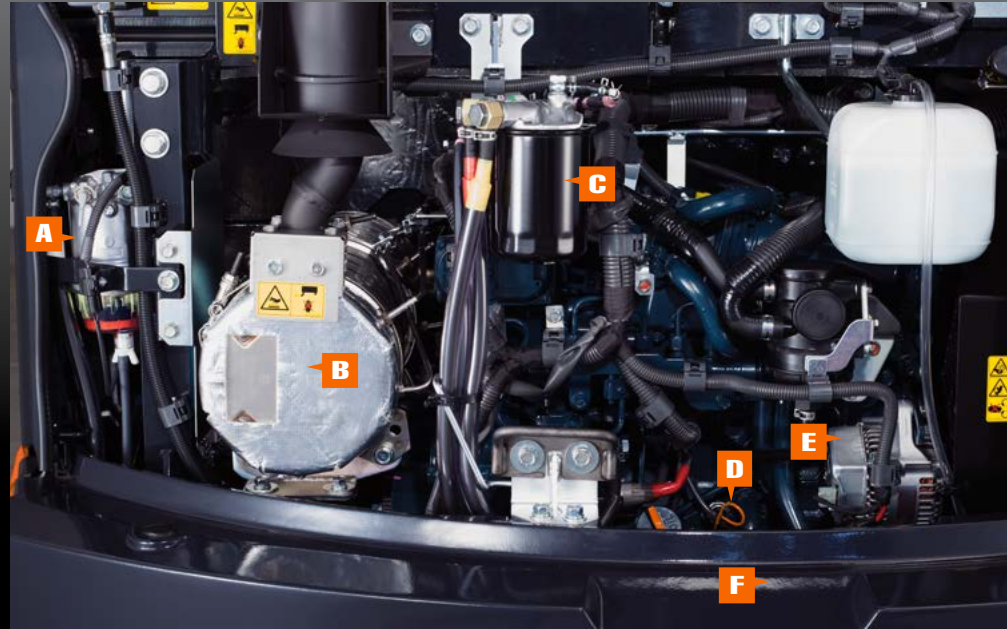

- A WATER SEPARATOR
- B DPF MUFFLER
- C FUEL FILTER
- D ENGINE OIL GAUGE
- E ALTERNATOR
- F STARTER MOTOR

One-sided Engine Maintenance

Kubota has made routine maintenance extremely simple by consolidating primary engine components onto one side for easier access. Engine and other vital components can be inspected quickly and easily.

Side-hood Features

The radiator, oil cooler and A/C condensor are conveniently positioned inside the side-hood bonnet. The new layout and A/C condensor tilt open structure provides an easier and more efficient way to clean and maintain the cooling system. With this, you can keep your machine performing in the best condition and protect the excavator from overheating.

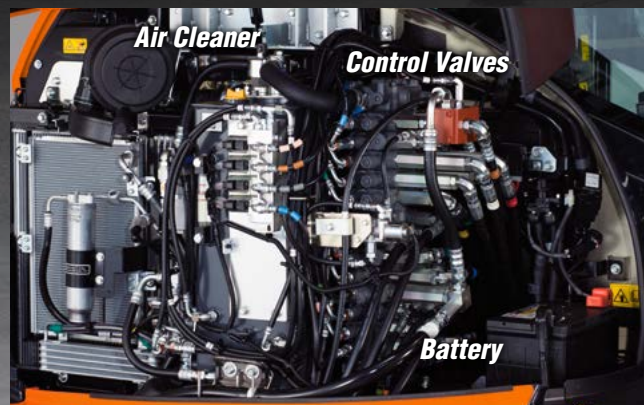

Two-piece Hose Design

The dozer blade's two-piece hose design reduces hose replacement by 60% compared to one-piece hoses.



Tool Storage Box with Grease Gun Holder

The tool storage box is conveniently located under the cab door for quick access. The box also features a grease gun holder to keep the grease gun within easy reach during maintenance.



DIGITAL PANEL

Intuitive operation and large LCD screen help to enhance performance.

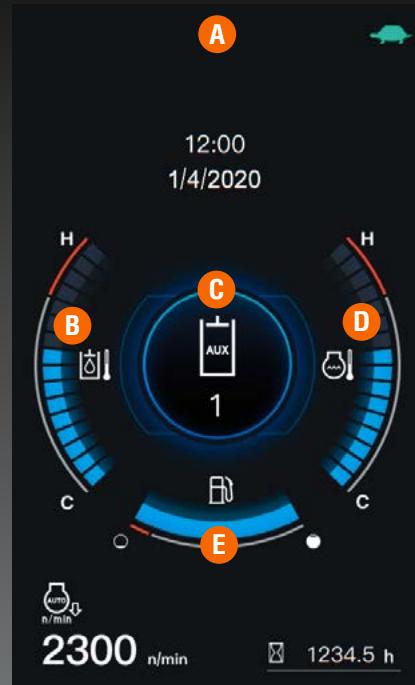

Standard Monitor Display

NEW FULL-COLOR LCD SCREEN WITH JOG DIAL

A full-color, high-resolution 7" LCD screen provides with a single glance all the information the operator needs to operate the compact excavator. An intuitive interface ensures quick understanding and easy access to the compact excavator's various functions, including AUX flow adjustment. Important maintenance items are also displayed, as are detailed alerts for improper machine functions and abnormalities. The new jog dial is both intuitive and easy to use. Even first-time operators will be able to quickly access all important information. Optional keyless start system is available for the operator's convenience.

Menu icons

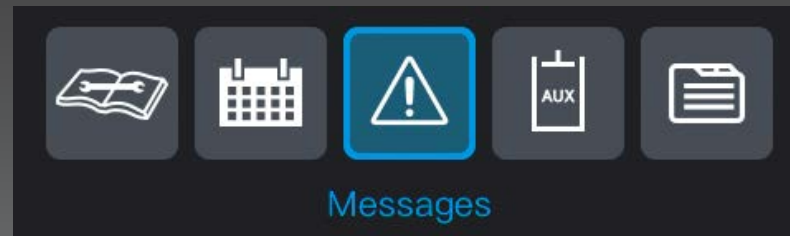

- A Alert Indicator
- B Hydraulic Temperature
- C AUX Mode
- D Water Temperature
- E Fuel Level

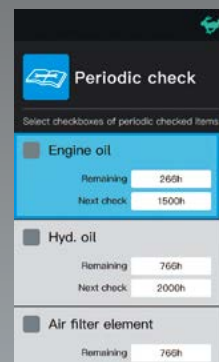

Periodic Check



Log Record

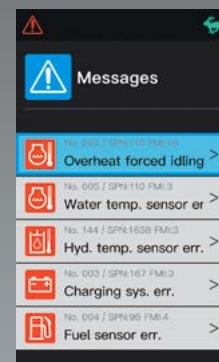

Message Mode

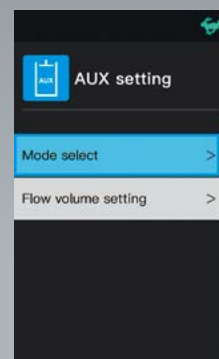

AUX Setting

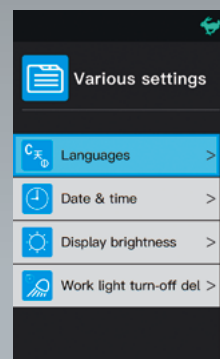

Various Setting

- A. Menu Key
- B. Return Key
- C. Jog Dial
- D. Working Light
- E. Beacon Light (Opt.)
- F. Auto Idle
- G. Wiper
- H. Rear-view Camera (Opt.)
- I. Washer Fluid
- J. Travel Alarm Off (Opt.)



U55-5 OPTIONS

Standard Equipment

Safety system

- Engine start safety system
- Travel motor with disc brake
- Swivel motor with disc brake
- All hydraulic control

Working equipment

- Auxiliary hydraulic circuit 1
- 2 LED working lights on cab and 1LED light on the boom
- Thumb bracket and relief valve

Operator's space

- ROPS/FOPS canopy
- Double adjustable seat
- Retractable seat belt
- Hydraulic pilot control levers with wrist rests
- Travel levers with foot pedals
- Two pattern selection system
- 7" Full Color LCD screen
- 12V power source
- Cup holder
- Horn

Engine/Fuel system

- Double element air filter
- Auto idling system
- Water separator with drain cock

Undercarriage

- Dozer blade with float
- 400 mm rubber track
- 1 × upper track roller
- 5 double-flange track rollers on each side
- 2-speed travel switch on dozer lever
- 2-speed travel with auto-shift

Hydraulic system

- 3-pump load sensing system
- Pressure accumulator
- Hydraulic pressure checking ports
- Straight travel circuit
- Automatic activation of third line hydraulic return
- Adjustable maximum oil flow on auxiliary hydraulic circuits 1
- Auxiliary switch (AUX1) on right control lever

Others

- Tool box
- Grease gun holder

Optional Equipment

- Cab with A/C
- Rear working lights
- 1'3.7" (400 mm) steel track for Angle blade model
- Additional auxiliary hydraulic circuit 2 (adjustable max. oil flow control)
- Angle blade with float function and BOE
- Travel alarm
- Air suspension seat
- Rear-view camera
- Canopy lights (LED)
- Beacon lights
- Keyless start
- Front guard
- Rear-view mirror

Stay connected with KubotaNOW

KubotaNOW telematics gives you the right information, when and where you need it. To access KubotaNOW telematics information, download the myKubota app and stay connected to your Kubota machine. Get information like hours, fuel level, location, temperatures, error codes, and more.



Working Range

Model		U55-5	
A	Max. digging height	ft. in. (mm) 18'6" (5635)	
B	Max. dumping height	ft. in. (mm) 13'1" (4000)	
C	Max. digging depth	ft. in. (mm) 11'11" (3630)	
D	Max. vertical digging depth	ft. in. (mm) 4'11.6" (1515)	
E	Max. digging radius, at ground level	ft. in. (mm) 19'7" (5965)	
F	Max. digging radius	ft. in. (mm) 20'0" (6105)	
G	Min. turning radius	W/o swing	ft. in. (mm) 8'0.8" (2460)
		With swing	ft. in. (mm) 6'8" (2020)
H	Min. tail turning radius	ft. in. (mm) 3'6" (1065)	

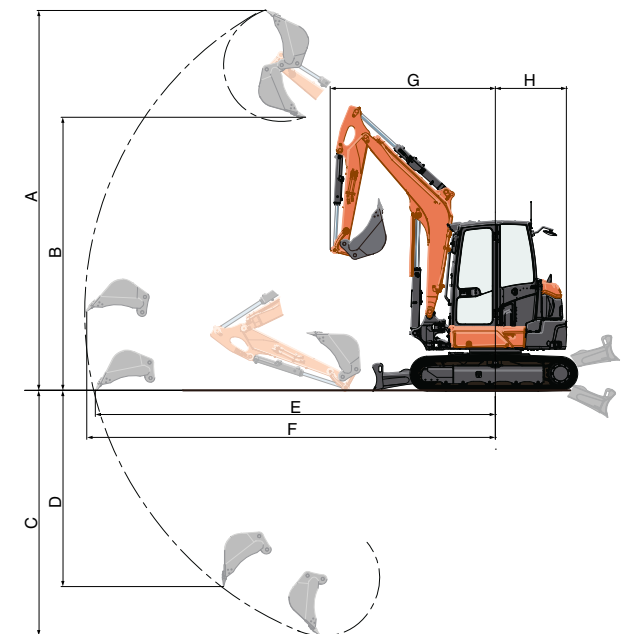

Lifting Capacity

LIFT POINT HEIGHT (ft)	LIFTING CAPACITY OVER-FRONT BLADE DOWN unit=1000 lbs			LIFTING CAPACITY OVER-SIDE unit=1000 lbs		
	LIFT POINT RADIUS (ft)			LIFT POINT RADIUS (ft)		
	12	16	MAX	12	16	MAX
10	2.52	-	-	2.13	-	-
8	2.81	2.45	2.22	2.07	1.32	1.23
4	3.57	2.63	2.34	1.92	1.27	1.13
GL	3.98	2.68	2.50	1.82	1.23	1.16

Machine with canopy, standard blade and rubber track, without bucket

